

# SIGNAL-CONDITIONED ULTRA-LOW PRESSURE SENSOR

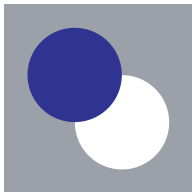

**SILICON  
MICROSTRUCTURES**  
INCORPORATED  
*Member of the ELMOS Group*

Product Number: SM5852-001

## HIGHLIGHTS

- FULLY AMPLIFIED, PRESSURE CALIBRATED AND TEMPERATURE COMPENSATED IN A SINGLE PACKAGE
- BOTH ANALOG AND DIGITAL PRESSURE OUTPUT WITH ACCESS TO TEMPERATURE SIGNAL-CONDITIONED DIGITAL ANALOG AND DIGITAL PRESSURE OUTPUT
- AVAILABLE FOR DIFFERENTIAL, GAUGE & SINGLE-ENDED APPLICATIONS
- 2<sup>ND</sup> GENERATION CERAMIC PACKAGE AND TUBES FOR HIGH RELIABILITY
- RUGGED AND HIGHLY STABLE CERAMIC PACKAGE
- UNIQUE LOW-PRESSURE DIE ALLOWS FOR A FULL-SCALE PRESSURE RANGE OF 0-0.15 PSI (1.0 kPa)

## TYPICAL APPLICATIONS

- Barometric measurement
- Medical instrumentation
- Pneumatic control
- Gas flow
- Heating, Ventilation and Air Conditioning (HVAC)

## TECHNICAL FEATURES

- Amplified, calibrated, fully signal-conditioned output span of 4.0 VDC full-scale
- Analog and digital temperature compensated and calibrated pressure available
- Multi-order correction for pressure non-linearity and for temperature coefficient of span and offset (factory programmed)
- Digital read-out through I<sup>2</sup>C interface
- Output is ratiometric with supply voltage
- Variety of versions (differential, gauge, and single-ended), depending on the pressure range



## DESCRIPTION

The Silicon Microstructures SM5852 series of OEM pressure sensors combines state-of-the-art pressure sensor technology with CMOS mixed signal processing technology to produce an amplified, fully conditioned, multi-order pressure and temperature compensated sensor in a dual in-line package (DIP) configuration.

Combining the pressure sensor with a custom signal conditioning ASIC in a single package simplifies the use of advanced silicon micromachined pressure sensors. The pressure sensor can be mounted directly to a standard printed circuit board and an amplified, high-level, calibrated pressure signal can be acquired from the digital interface or analog output. This eliminates the need for additional circuitry, such as a compensation network or micro-controller containing a custom correction algorithm.

The SM5852 Series pressure sensors are based on SMI's highly stable, piezoresistive pressure sensor chips mounted on a ceramic substrate.

The model SM5852 is designed for operating pressure ranges of 0-0.15 PSI (1.0 kPa).



Product Number: SM5852-001

## ABSOLUTE MAXIMUM RATING TABLE FOR SM5852

All parameters are specified at  $V_{SUPPLY} = 5.00$  V DC supply at room temperature, unless otherwise noted.

No.	Characteristic	Symbol	Minimum	Typical	Maximum	Units
1	Excitation Voltage <sup>(a, b)</sup>	$V_{SUPPLY}$	4.75	5.00	5.25	V
2	Current Consumption <sup>(c)</sup>	$I_{SUPPLY}$		7	10	mA
3	Proof Pressure <sup>(d, e)</sup>	$P_{PROOF}$	10x			$P_{RANGE}$
4	Burst Pressure <sup>(d, e)</sup>	$P_{BURST}$	15x			$P_{RANGE}$
5	Operating Temperature <sup>(f)</sup>	$T_{OP}$	-40		+125	°C
6	Storage Temperature <sup>(f)</sup>	$T_{STG}$	-40		+150	°C
7	Media Compatibility <sup>(f, g)</sup>					

## OPERATING CHARACTERISTICS FOR SM5852 - SPECIFICATIONS

All parameters are specified at  $V_{SUPPLY} = 5.00$  V DC supply at room temperature, unless otherwise noted.

### Gauge & Single-ended<sup>(h)</sup> Pressure Sensors

No.	Characteristic	Symbol	Minimum	Typical	Maximum	Units
8	Span (FS $p_{RANGE}$ ) <sup>(a, b, d, e, i)</sup>	$V_{SPAN}$	3.80	4.00	4.20	V FS
9	Zero Offset <sup>(j, k)</sup>	$V_{ZERO}$	0.42	0.50	0.58	V
10	Total Accuracy <sup>(f, l)</sup>	$ACC_{RSS}$			2.0	%FS
11	Pressure Response Time <sup>(f, m)</sup>	$t_{RESP}$		2		ms
12	Warm-up Deviation <sup>(f, n)</sup>	$ACC_{WUD}$		0.4		%FS
13	Linearity <sup>(o)</sup>	NL	-1.3		1.3	%FS
14	Compensated Temp. Range	$T_{COMP}$	15		75	°C

### Differential<sup>(b)</sup> Pressure Sensors

No.	Characteristic	Symbol	Minimum	Typical	Maximum	Units
15	Span (FS $p_{RANGE}$ ) <sup>(a, b, d, e, i)</sup>	$V_{SPAN}$	1.90	2.00	2.10	V FS
16	Zero Offset <sup>(j, k)</sup>	$V_{ZERO}$	2.42	2.50	2.58	V
17	Total Accuracy <sup>(f, l)</sup>	$ACC_{RSS}$			2.0	%FS
18	Pressure Response Time <sup>(f, m)</sup>	$t_{RESP}$		2		ms
19	Warm-up Deviation <sup>(f, n)</sup>	$ACC_{WUD}$		0.4		%FS
20	Linearity <sup>(o)</sup>	NL	-1.3		1.3	%FS
21	Compensated Temp. Range	$T_{COMP}$	15		75	°C

Product Number: SM5852-001

---

NOTES:

- (a) Specified parameter values will not be met when supply voltage is not 5.00 V.
- (b) A 100 nF filter capacitor (capacitor type: X7R or X2Y) must be placed between VDD and GND in a maximum distance of 5 mm. See wiring diagram for optimal signal conditioning of the pressure device.
- (c) Operating values for the current consumption. The current draw may be higher upon power-up of the device.
- (d) For the SM5852 series the specified values apply for positive (top side) pressure only.
- (e) The output voltage value will saturate at about 4.75 V for applied pressure above the rated full-scale.
- (f) Tested on a sample basis.
- (g) Clean, dry gas compatible with wetted materials. Wetted materials include Pyrex glass, silicon, alumina ceramic, epoxy, RTV, gold, aluminum, and nickel.
- (h) Single-ended parts (pressure type - S) have 2 ports and are for higher gain differential applications, where the differential pressure is always positive.
- (i) Full-scale (FS) is defined as zero pressure to rated pressure; differential parts can be used  $\pm$ FS. Gauge zero output is 0.5 V, typical, and full-scale output is typically 4.5 V. Span is the difference between full-scale output and zero output, (typical 4 V). For differential parts, the negative full-scale is typically at 0.5 V, zero is typically 2.5 V, and positive (topside) full-scale is 4.5 volts, typical, to give a span of  $\pm$ 2.0 V, typical.
- (j) Due to the sensitivity of the SM5852 series, external mechanical stresses and mounting position can affect the zero pressure output reading.
- (k) The output offset voltage value will saturate at about 0.25 V for applied pressure below the pressure-type related minimum pressure value.
- (l) The total accuracy is defined by the root of the sum of the squares (RSS) of the individual components contributing to the total error. The main contributors are the temperature coefficient of zero offset (TCZ), the temperature coefficient of span (TCS), the non-linearity (NL), the temperature (Tp) and the pressure hysteresis (Hp). The given value applies to the compensated temperature range.
- (m) The pressure response time is the amount of time, which the ASIC needs to update the pressure values within the internal registers.
- (n) The warm-up deviation is the deviation from the total accuracy (l) of the output values upon each biasing of the device at supply voltage over a period of the first 60 seconds.
- (o) The non-linearity calculation uses the "best-fit-straight-line" (BFSL) approach.

Product Number: SM5852-001

## Package Dimensions & Pin-Out

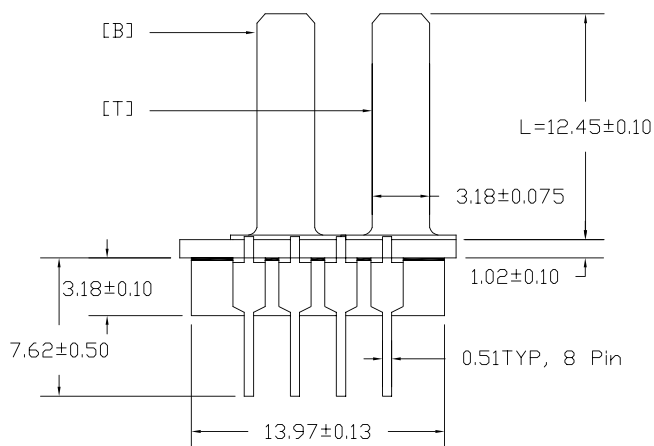

Side View

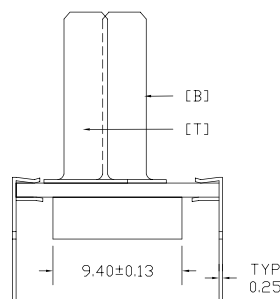

PIN	DESCRIPTION
1	NC
2	GND
3	NC
4	SDA
5	SCL
6	NC
7	VDD
8	ANALOG OUT

All dimensions are shown in millimeters

**NOTES:**

- Do not connect to NC pins.
- External connections to NC pins will cause part malfunction.
- Tolerance on all dimensions  $\pm 0.13$  mm unless otherwise specified.
- [B] is tube connected to bottom side of sensor die.
- [T] is tube connected to top side of sensor die.

**Pin Configuration**

\* Pins opposite direction of tube

**Tube Length**

L: Long (12.45 mm  $\pm$  0.10 mm)

**Pressure Type**

- D: Differential (2 Tubes)
- S: Single-Ended (2 Tubes)

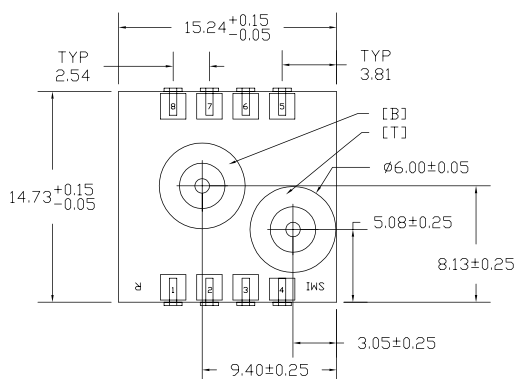

Top View

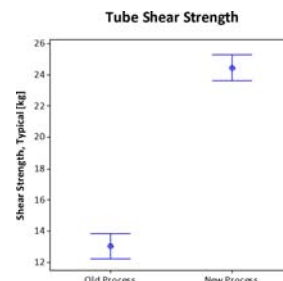
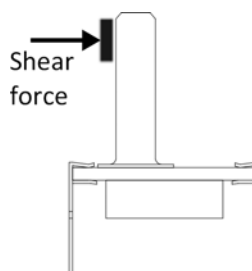

## Ordering information

Order Code	Pressure Type	Full-Scale Pressure Range	Tube Length
5852-001-D-3-LR	Differential	0.15 PSI / 1.0 kPa	Long
5852-001-S-3-LR	Single-ended	0.15 PSI / 1.0 kPa	Long

For samples, please contact [sales@si-micro.com](mailto:sales@si-micro.com)

**QUALIFICATION STANDARDS**

→ For qualification specifications, please contact Sales at [sales@si-micro.com](mailto:sales@si-micro.com)

Product Number: SM5852-001

## Wiring Diagrams

- VDD** The optimum operation value for the power supply is 5.00 V.
- R1/R2** Pull-up resistors for the digital data lines. Recommended resistor values are 10 to 100 kOhm.
- C1a/C1b** Buffer capacitor. For best performance of the sensor output signals it is obligatory to use a 100 nF buffer capacitor between the supply pins VDD and GND of the sensor device. SMI recommends high quality capacitors, such as X7R or X2Y. The maximum distance between the package supply pins and this capacitor should be no more than 5 mm. Usually this buffer capacitor is sufficient, but in connection with a poor power supply and to reduce power consumption a reload capacitor (C2) of min. 1  $\mu\text{F}$  is advised. In this case, SMI recommends using ceramic capacitors of 47  $\mu\text{F}$ .
- C3** Capacitive load of the analog output. The capacitive load should be between 15 nF to 33 nF (recommended: 22 nF) with a resistor (optional: R3) of min. 3 kOhm. For a chosen lower capacitive load of 1 nF to 15 nF the resistor value should be at least 6.8 kOhm.
- R4** Optional resistor for low-pass filtering (in lieu of R3) of the analog output. The recommended resistor value is: 4.7 kOhm

\* Obligatory components for best performance of pressure sensor device.

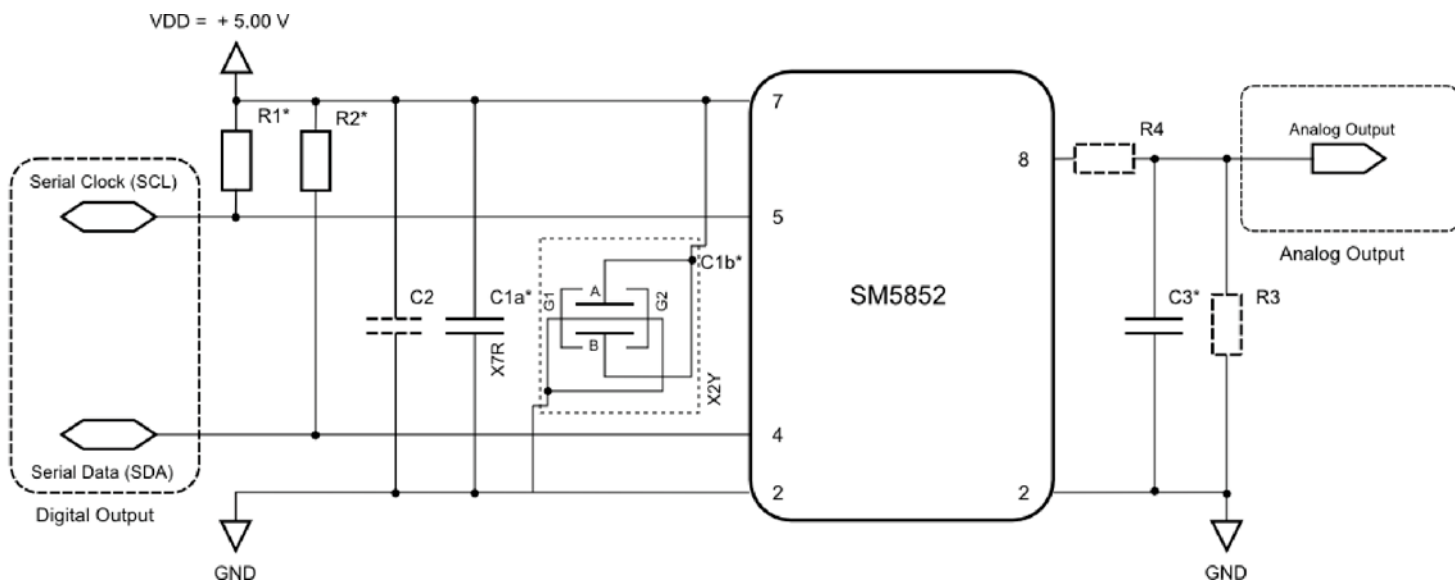

Product Number: SM5852-001

---

## Silicon Microstructures Warranty and Disclaimer:

Silicon Microstructures, Inc. reserves the right to make changes without further notice to any products herein and to amend the contents of this data sheet at any time and at its sole discretion.

Information in this document is provided solely to enable software and system implementers to use Silicon Microstructures, Inc. products and/or services. No express or implied copyright licenses are granted hereunder to design or fabricate any silicon-based microstructures based on the information in this document.

Silicon Microstructures, Inc. makes no warranty, representation, or guarantee regarding the suitability of its products for any particular purpose, nor does Silicon Microstructures, Inc. assume any liability arising out of the application or use of any product or silicon-based microstructure, and specifically disclaims any and all liability, including without limitation consequential or incidental damages. "Typical" parameters which may be provided in Silicon Microstructure's data sheets and/or specifications can and do vary in different applications and actual performance may vary over time. All operating parameters, including "Typicals", must be validated for each customer application by customer's technical experts. Silicon Microstructures, Inc. does not convey any license under its patent rights nor the rights of others. Silicon Microstructures, Inc. makes no representation that the circuits are free of patent infringement. Silicon Microstructures, Inc. products are not designed, intended, or authorized for use as components in systems intended for surgical implant into the body, or other applications intended to support or sustain life, or for any other application in which the failure of the Silicon Microstructures, Inc. product could create a situation where personal injury or death may occur. Should Buyer purchase or use Silicon Microstructures, Inc. products for any such unintended or unauthorized application, Buyer shall indemnify and hold Silicon Microstructures, Inc. and its officers, employees, subsidiaries, affiliates, and distributors harmless against all claims, costs, damages, and expenses, and reasonable attorney fees arising out of, directly or indirectly, any claim of personal injury or death associated with such unintended or unauthorized use, even if such claim alleges that Silicon Microstructures, Inc. was negligent regarding the design or manufacture of the part.

Silicon Microstructures, Inc. warrants goods of its manufacture as being free of defective materials and faulty workmanship. Silicon Microstructures, Inc. standard product warranty applies unless agreed to otherwise by Silicon Microstructures, Inc. in writing; please refer to your order acknowledgement or contact Silicon Microstructures, Inc. directly for specific warranty details. If warranted goods are returned to Silicon Microstructures, Inc. during the period of coverage, Silicon Microstructures, Inc. will repair or replace, at its option, without charge those items it finds defective. The foregoing is buyer's sole remedy and is in lieu of all warranties, expressed or implied, including those of merchantability and fitness for a particular purpose. In no event shall Silicon Microstructures, Inc. be liable for consequential, special, or indirect damages.

While Silicon Microstructures, Inc. provides application assistance personally, through its literature and the Silicon Microstructures, Inc. website, it is up to the customer to determine the suitability of the product for its specific application. The information supplied by Silicon Microstructures, Inc. is believed to be accurate and reliable as of this printing. However, Silicon Microstructures, Inc. assumes no responsibility for its use. Silicon Microstructures, Inc. assumes no responsibility for any inaccuracies and/or errors in this publication and reserves the right to make changes without further notice to any products or specifications herein

Silicon Microstructures, Inc.<sup>TM</sup> and the Silicon Microstructures, Inc. logo are trademarks of Silicon Microstructures, Inc. All other service or product names are the property of their respective owners.

© Silicon Microstructures, Inc. 2001-2011. All rights reserved.